

REVISION	DESCREPTION	DATE	APPD
0	SET UP	MAR/17/2000	C.Y.LIN

3000

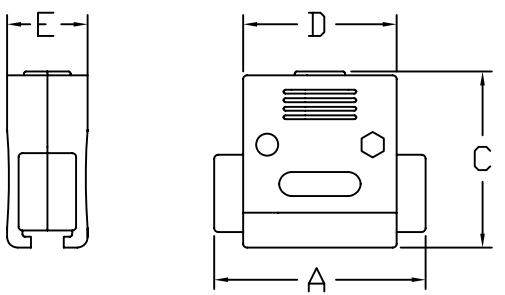

3100

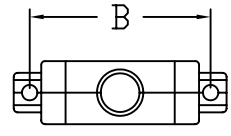
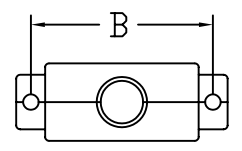
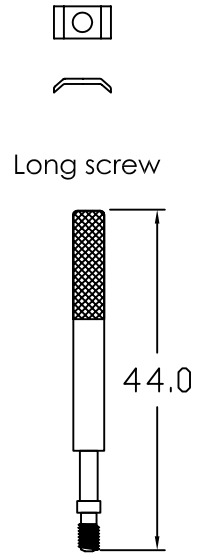
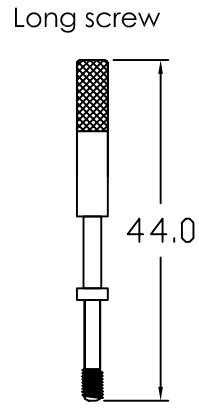
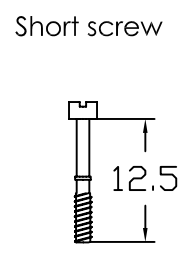
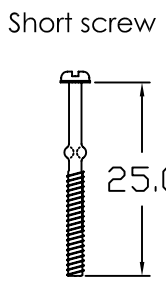
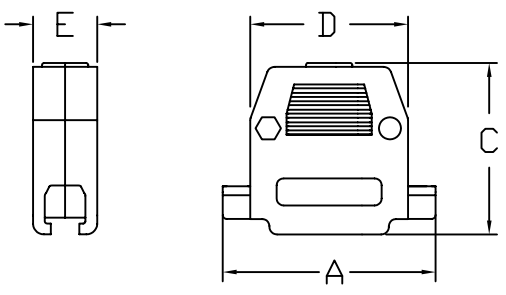

3000 & 3100 - [ ] [ ] [ ]

- SCREW TYPE**
- 0 = Short screw (4-40 thread)
  - 1 = Long screw (4-40 thread)
- NO. OF CONTACT**
- 1=9Pin
  - 2=15Pin
  - 3=19Pin
  - 4=23Pin
  - 5=25Pin
  - 6=37Pin
  - 7=50Pin

- HOOD TYPE**
- Blank=Grey color hood
  - Bk=Black color hood
  - C=Chromate plated hood

- KITS CONSIST OF a~d :**
- a. 12.0~16.0mm 4-40 thread screw 2pcs
  - b. Nut 2pcs
  - c. 7.0mm 4-40 thread screw 2pcs
  - d. S/R 2pcs

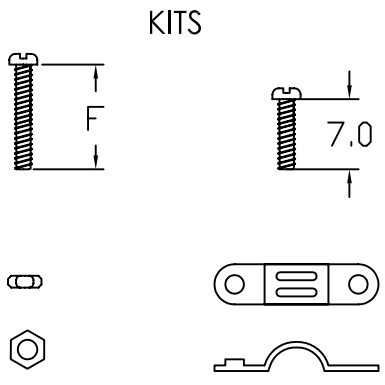

MATERIAL  
HOOD : UL 94 HB ABS

3000 Dimension ( mm ) Tolerance : ±0.2

Position	A	B	C	D	E	F
9	33.0	25.0	46.0	18.0	20.0	13.0
15	41.3	33.3	46.0	26.3	20.0	13.0
25	54.6	47.0	45.5	39.7	20.8	13.0
37	71.5	63.5	45.8	56.6	20.2	13.0
50	69.5	61.1	45.2	54.5	20.0	13.0

3100 Dimension ( mm ) Tolerance : ±0.2

Position	A	B	C	D	E	F
9	31.0	25.1	40.0	20.5	16.0	12.0
15	39.6	33.7	36.8	27.8	16.3	13.0
19	33.8	/	43.0	/	16.0	13.0
23	50.3	44.3	41.5	39.5	16.4	13.0
25	55.0	46.8	44.3	40.8	16.6	16.0
37	69.5	63.3	53.4	57.6	24.2	16.0



HO CHIEN ENTERPRISE CO. LTD

TITLE:  
**D - SUB CONNECTOR PLASTIC HOOD**

DR: RON CHEN	CHK: J.T,CHEN	APPD: C.Y.LIN
--------------	---------------	---------------

PAGE: 1 OF 1	HO CHIEN P/N. 3000 & 3100 SERIES
--------------	----------------------------------