

3988-04R

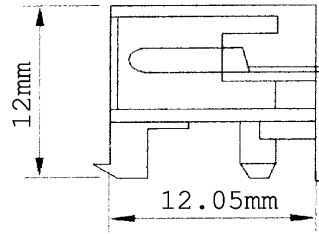

3988-04

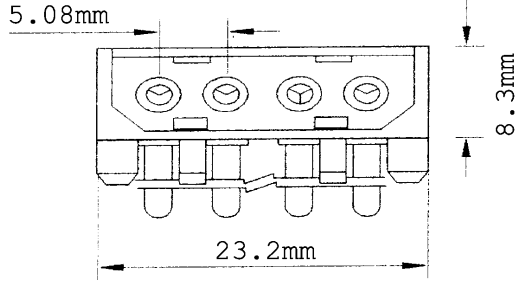
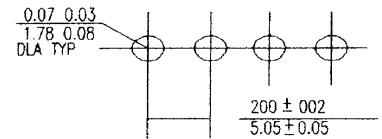
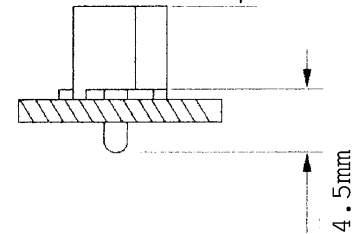
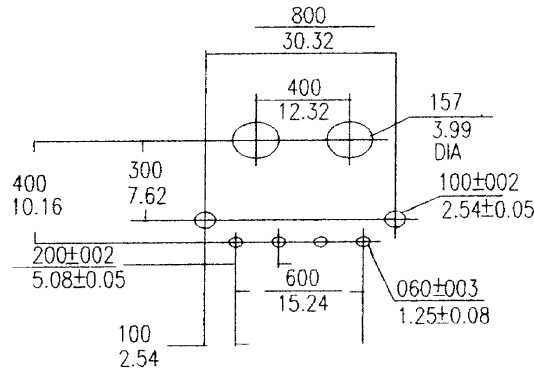
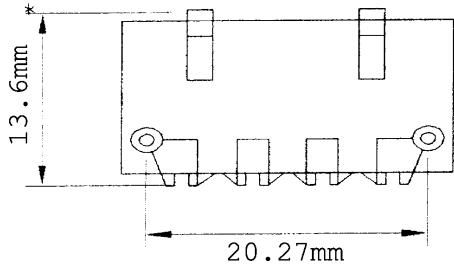
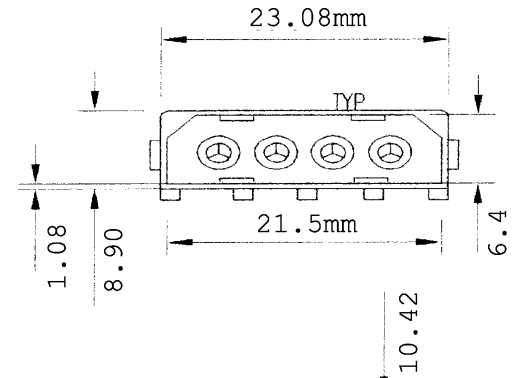

MATERIAL : Brass
 FINISH : Tin-plated
 RATED CURRENT 7A
 RATED VOLTAGE 250 Volts AC

TOLERANCE ± 0.25



HO CHEN ENTERPRISE CO. LTD

TITLE : 5.08 mm (.200") Pitch

PAGE: 1 OF 1

P/O NO. 3988-04
 3988-04R